

PERMCO

DUMP PUMPS

PUMP/VALVE ASSEMBLY FOR HEAVY AND MEDIUM DUTY DUMP TRUCKS AND TRAILERS

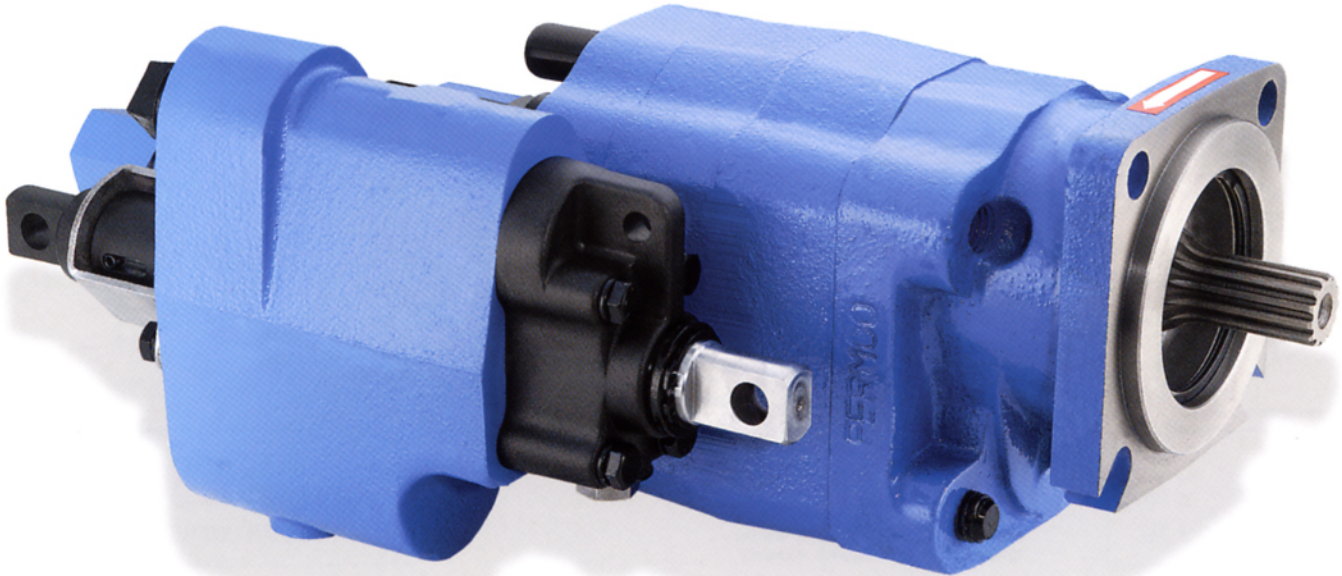

DUMP PUMP FEATURES

- Pump and cylinder protected in the “Raise” and “Neutral” position of the spool
- Manual shift, factory installed “OE” air, or “Add-on” air shifts each with full metering capabilities
- Built-in load check maintains dump body angle and is installed in the cylinder port for superior self-clear
- Direct mount SAE “B” 4 bolt or twin shafted remote mount with bracket
- Heavy duty “controlled stress” roller bearings
- Built-in direct acting relief valve set at factory
- 100% factory tested
- Flows of 37 and 46 GPM at 1800 RPM
- Pressures to 2500 PSI
- Speeds to 2400 RPM
- High strength alloy steel gear and shaft set
- Neutral lock-out safety cap for use with pull-out cable
- 2 line for intermittent duty or 3 line for continuous duty systems
- 2 extra long studs for easy installation of pump support bracket on direct mount
- Pressure balanced wear plates maintain high pump efficiency throughout all operating ranges

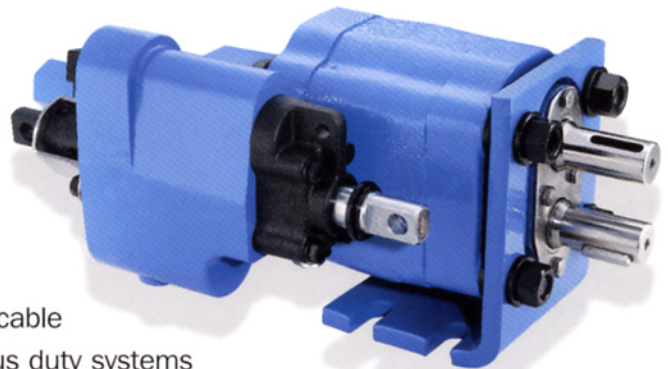

The Sensible Choice

Dimensional Data (inches)

Dump Pumps are not recommended for ejector, conveyor, or moving floor type applications.

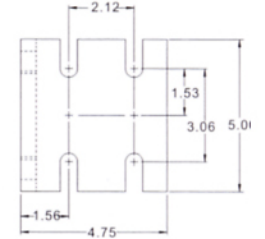
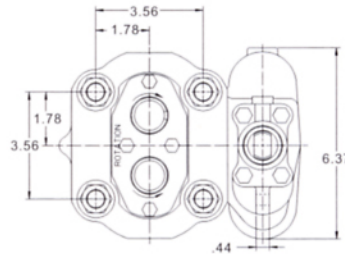
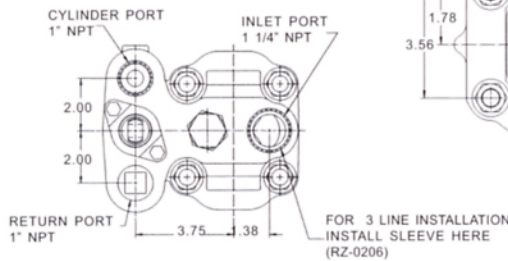
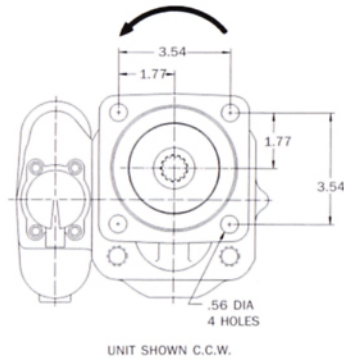
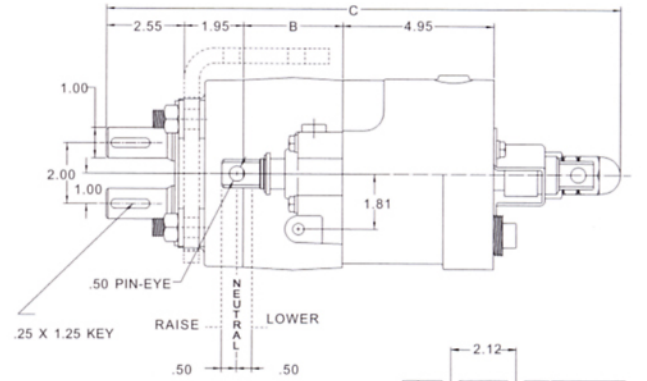
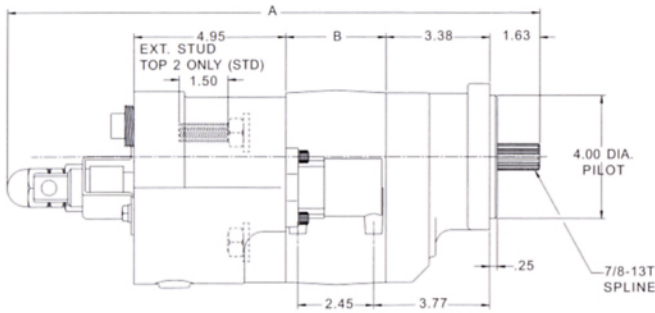

	A	B
DMD-20	16.85"	2.75"
DMD-25	17.35"	3.25"

PORT VIEW SHOWN FOR BOTH DIRECT AND REMOTE MOUNT

	C	B
DM-512-20	16.35"	2.75"
DM-640-25	16.85"	3.25"

Pump Code

DMD - 25 - Z - L - AS - 20 - EB

Direct Mount, SAE 4 Bolt "B"

20 2.0" Gear / 37 GPM at 1800 RPM
25 2.5" Gear / 46 GPM at 1800 RPM

X 2 Line (Without 3 Line Sleeve)
Z 3 Line (With 3 Line Sleeve)

L Left Hand Rotation
R Right Hand Rotation

Extended Stud Orientation

Delete Top Two (Std.)
EB Bottom Two
EL Left Side
ER Right Side
E4 All four

Relief Valve Setting

20 2000 PSI
25 2500 PSI

AS Air Shift
MS Manual Shift

DM - 640 - 25 - ZR - M - T - 200

Remote Mount

512-20 In.³ x 100 / 2.0" Gear / 37 GPM at 1800 RPM
640-25 In.³ x 100 / 2.5" Gear / 46 GPM at 1800 RPM

X 2 Line (Without 3 Line Sleeve)
Z 3 Line (With 3 Line Sleeve)

Valve Orientation

L Left Side
R Right Side (Std.)

Relief Valve Setting

200 2000 PSI
250 2500 PSI

T Manual Shift
AS "OE" Air Shift

M With Mounting Bracket (Std.)
O Without Mounting Bracket



www.permco.com

1500 Frost Rd.
P. O. Box 2068
Streetsboro, OH 44241

Phone 330-626-2801
Fax 330-626-2805
e-mail info@permco.com

© Bulletin #96-601A